



LEAPTON
SOLAR

Monofacial

Bifacial

LP182*210-M-54-NB N-Type TOPCon Dual Glass

Rated Power 490-520W

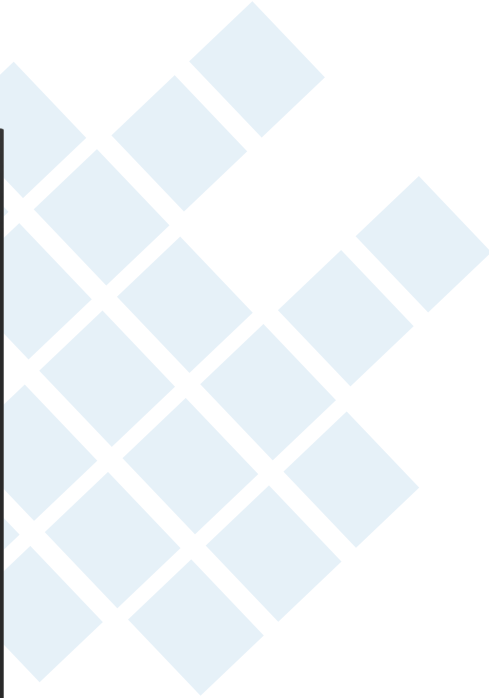
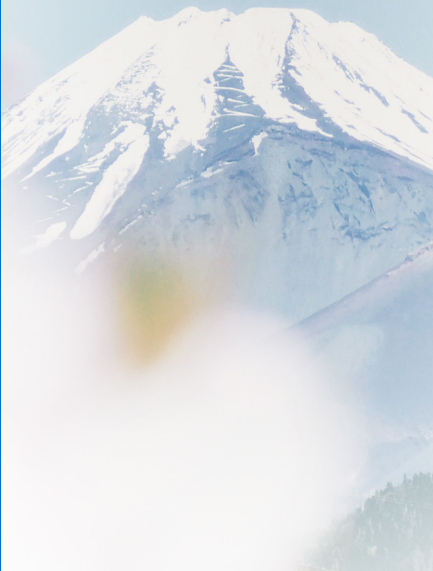
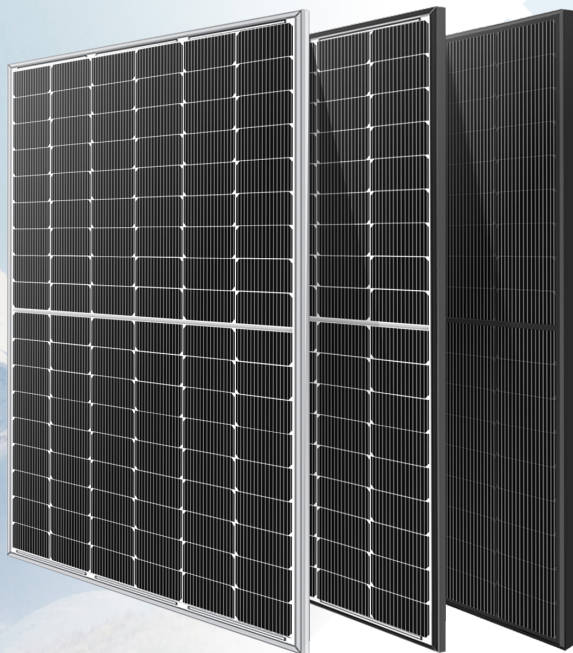

N-Type 182*210mm Cell
Adopting the 182*210mm N-Type TOPCon solar cells with the highest efficiency.



Low Light Features
Higher performance under low light environment.



Bifacial with dual glass
Module adopts 182*210mm half cells, bifacial module provide an additional 5%~25% output.



PID Protection
Ensure the attenuation probability caused by PID phenomenon is minimized.



Harsh Environmental Adaptability
Strict salt spray and ammonia corrosion test by TUV Nord.



Load Capacity
Mechanical load tests including wind load 2400 Pa and snow load 5400 Pa done by TUV Nord.

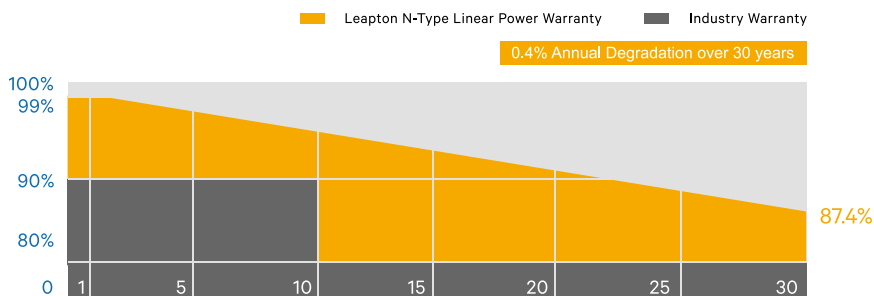

Headquarter(Kobe-shi) : Leapton Energy Co., Ltd.

Tosei Bldg. 6F, 1-2-1 Aioi-cho, Chuo-ku Kobe-shi, Hyogo, 650-0025, Japan ☎ +81-78-382-3182 ✉ info-lp@leaptonenergy.jp 🌐 www.leaptonenergy.jp

Branch Office(Tokyo)

Shinsan Bldg. 6F, 3-5-10 Shimbashi, Minato-Ku, Tokyo 105-0004, Japan ☎ +81-3-5510-7818

Manufacturer : Leapton Solar (Changshu) Co., Ltd. 📍 No.9, Sunshine Avenue, Changshu City, Jiangsu, China

MECHANICAL DIAGRAMS

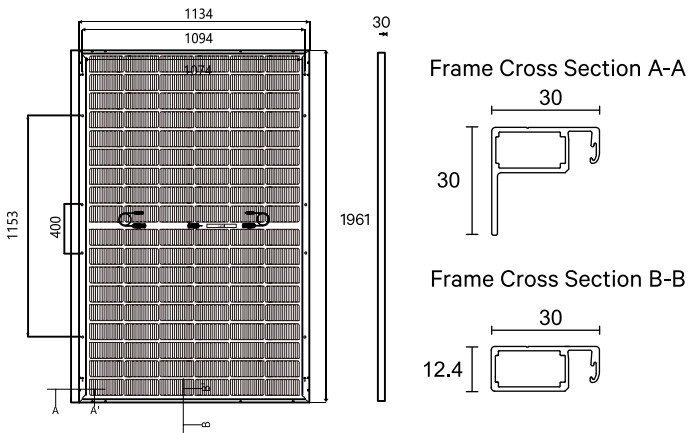

SPECIFICATIONS

Weight	26.6kg
Dimensions	1961mm*1134mm*30mm
Cell Dimensions	182*210mm
Cell Amount	54*2 pcs
Maximum System Voltage	1500V
Junction Box	IP68
Front glass	2.0mm, Anti-Reflection Coating
Back glass	2.0mm, Heat Strengthened Glass
Frame	Aluminum Alloy
Cable	4mm ² , N 1200mm/P 1200mm for Horizontal installation 4mm ² , N 300mm/P 300mm for Vertical installation
Connector	MC4 compatible
Bifaciality	80±5%

ELECTRICAL PARAMETERS AT STC

Power	490W	495W	500W	505W	510W	515W	520W
Open Circuit Voltage	39.57V	39.82V	40.07V	40.32V	40.57V	40.82V	41.07V
Short Circuit Current	15.78A	15.84A	15.90A	15.96A	16.01A	16.05A	16.10A
Maximum Power Voltage	32.93V	33.13V	33.33V	33.53V	33.73V	33.93V	34.13V
Maximum Power Current	14.88A	14.94A	15.00A	15.06A	15.12A	15.18A	15.24A
Module Efficiency	22.03%	22.26%	22.48%	22.71%	22.93%	23.16%	23.38%

* Under Standard Test Conditions (STC) of irradiance of 1000 W/m², spectrum AM 1.5 and cell temperature of 25°C.

ELECTRICAL PARAMETERS AT NMOT

Power	373W	377W	381W	384W	389W	393W	396W
Open Circuit Voltage	37.52V	37.79V	38.06V	38.33V	38.60V	38.80V	39.00V
Short Circuit Current	12.68A	12.76A	12.79A	12.81A	12.87A	12.94A	12.97A
Maximum Power Voltage	30.92V	31.12V	31.32V	31.52V	31.72V	31.92V	32.12V
Maximum Power Current	12.06A	12.11A	12.16A	12.18A	12.26A	12.31A	12.33A

* Under Nominal Module Operating Temperature (NMOT), irradiance of 800 W/m², spectrum AM 1.5, ambient temperature 20°C, wind speed 1 m/s.

ELECTRICAL PARAMETERS (AT 10% BIFACIAL POWER OUTPUT)

Output Power	539W	545W	550W	556W	561W	566W	572W
Open Circuit Voltage	39.57V	39.82V	40.07V	40.32V	40.57V	40.82V	41.07V
Short Circuit Current	17.31A	17.37A	17.44A	17.50A	17.56A	17.61A	17.69A
Maximum Power Voltage	32.93V	33.13V	33.33V	33.53V	33.73V	33.93V	34.13V
Maximum Power Current	16.37A	16.44A	16.50A	16.57A	16.63A	16.68A	16.76A

TEMPERATURE CHARACTERISTICS

NMOT	41±3°C	Temp Coefficient of ISC	+0.046%/°C
Temp Coefficient of VOC	-0.25%/°C	Temp Coefficient of Pmax	-0.30%/°C

PACKING CONFIGURATION

Modules/Pallet	37 Pieces	Modules/40'Container	888 Pieces
Packing Description	24 Pallets, Total=(37+37)x12=888 Pieces		

CHARACTERISTICS

LP182*210-M-54-NB-500W

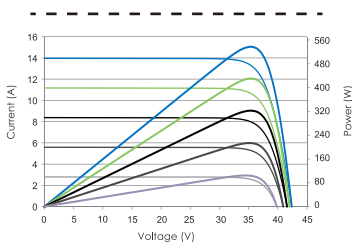

LP182*210-M-54-NB-500W

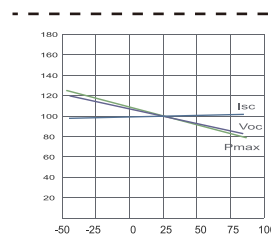

MAXIMUM RATING

Output Tolerance	0~+5W
Operating Temperature	-40°C~+85°C
Wind Load/Snow Load	2400pa/5400pa
Fuse Current	25A





LEAPTON
SOLAR

Monofacial

Bifacial

LP182*210-M-66-NB N-Type TOPCon Dual Glass

Rated Power 610-640W

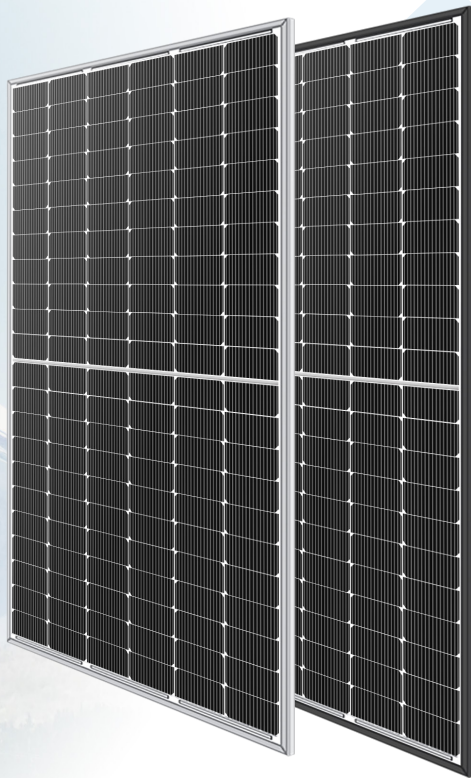

N-Type 182*210mm Cell
Adopting the 182*210mm N-Type TOPCon solar cells with the highest efficiency.



Low Light Features
Higher performance under low light environment.



Bifacial with dual glass
Module adopts 182*210mm half cells, bifacial module provide an additional 5%~25% output.



PID Protection
Ensure the attenuation probability caused by PID phenomenon is minimized.



Harsh Environmental Adaptability
Strict salt spray and ammonia corrosion test by TUV Nord.



Load Capacity
Mechanical load tests including wind load 2400 Pa and snow load 5400 Pa done by TUV Nord.

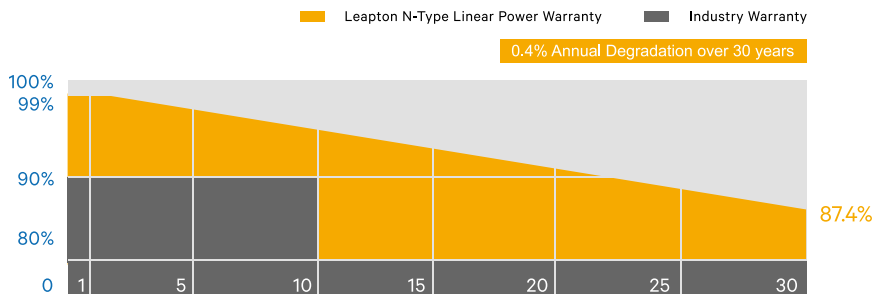

MECHANICAL DIAGRAMS

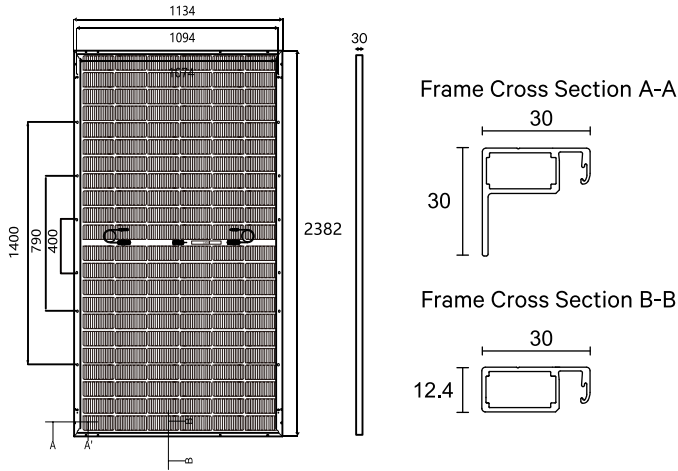

SPECIFICATIONS

Weight	31kg
Dimensions	2382mm*1134mm*30mm
Cell Dimensions	182*210mm
Cell Amount	66*2 pcs
Maximum System Voltage	1500V
Junction Box	IP68
Front glass	2.0mm, Anti-Reflection Coating
Back glass	2.0mm, Heat Strengthened Glass
Frame	Aluminum Alloy
Cable	4mm ² , N 1400mm/P 1400mm for Horizontal installation 4mm ² , N 300mm/P 300mm for Vertical installation
Connector	MC4 compatible
Bifaciality	80±5%

ELECTRICAL PARAMETERS AT STC

Power	610W	615W	620W	625W	630W	635W	640W
Open Circuit Voltage	49.05V	49.35V	49.55V	49.75V	49.95V	50.15V	50.35V
Short Circuit Current	15.84A	15.88A	15.93A	16.00A	16.05A	16.11A	16.17A
Maximum Power Voltage	40.66V	40.86V	41.06V	41.26V	41.46V	41.66V	41.86V
Maximum Power Current	15.00A	15.05A	15.10A	15.15A	15.20A	15.24A	15.29A
Module Efficiency	22.58%	22.77%	22.95%	23.14%	23.32%	23.51%	23.69%

* Under Standard Test Conditions (STC) of irradiance of 1000 W/m², spectrum AM 1.5 and cell temperature of 25°C.

ELECTRICAL PARAMETERS AT NMOT

Power	465W	469W	472W	476W	480W	484W	488W
Open Circuit Voltage	46.51V	46.81V	47.01V	47.21V	47.41V	47.61V	47.81V
Short Circuit Current	12.78A	12.81A	12.84A	12.88A	12.93A	12.98A	13.03A
Maximum Power Voltage	38.20V	38.40V	38.60V	38.80V	39.00V	39.20V	39.40V
Maximum Power Current	12.17A	12.21A	12.23A	12.27A	12.31A	12.35A	12.39A

* Under Nominal Module Operating Temperature (NMOT), irradiance of 800 W/m², spectrum AM 1.5, ambient temperature 20°C, wind speed 1 m/s.

ELECTRICAL PARAMETERS (AT 10% BIFACIAL POWER OUTPUT)

Output Power	671W	677W	682W	688W	693W	699W	704W
Open Circuit Voltage	49.05V	49.35V	49.55V	49.75V	49.95V	50.15V	50.35V
Short Circuit Current	17.43A	17.47A	17.52A	17.57A	17.62A	17.69A	17.74A
Maximum Power Voltage	40.66V	40.86V	41.06V	41.26V	41.46V	41.66V	41.86V
Maximum Power Current	16.50A	16.57A	16.61A	16.67A	16.71A	16.78A	16.82A

TEMPERATURE CHARACTERISTICS

NMOT	41±3°C	Temp Coefficient of ISC	+0.046%/°C
Temp Coefficient of VOC	-0.25%/°C	Temp Coefficient of Pmax	-0.30%/°C

PACKING CONFIGURATION

Modules/Pallet	37 Pieces	Modules/40'Container	740 Pieces
Packing Description	20 Pallets, Total=(37+37)x10=740 Pieces		

CHARACTERISTICS

LP182*210-M-66-NB-620W

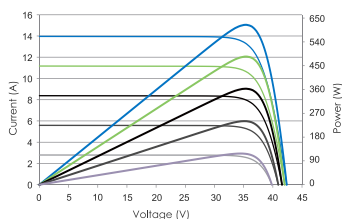

LP182*210-M-66-NB-620W

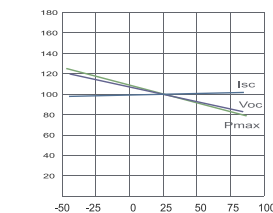

MAXIMUM RATING

Output Tolerance	0~+5W
Operating Temperature	-40°C~+85°C
Wind Load/Snow Load	2400pa/5400pa
Fuse Current	25A





LEAPTON
SOLAR

Monofacial

Bifacial

LP210*210-M-66-NB N-Type TOPCon Dual Glass

Rated Power 700-740W

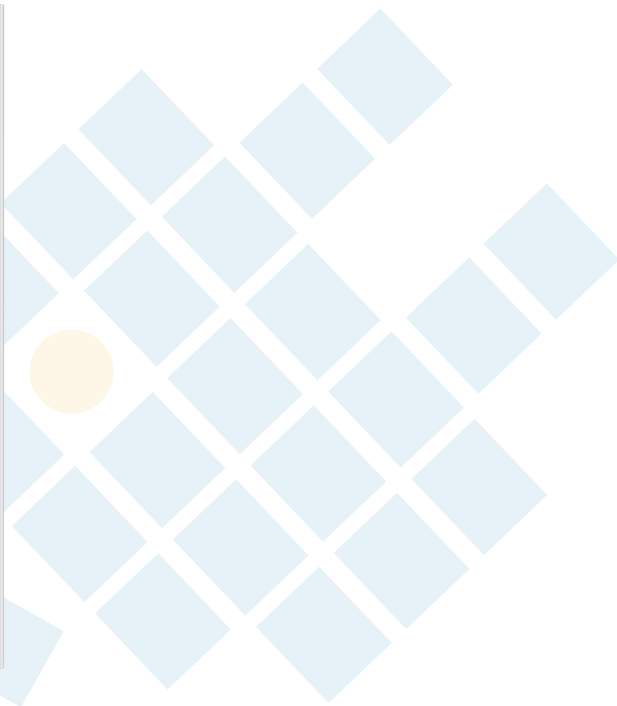
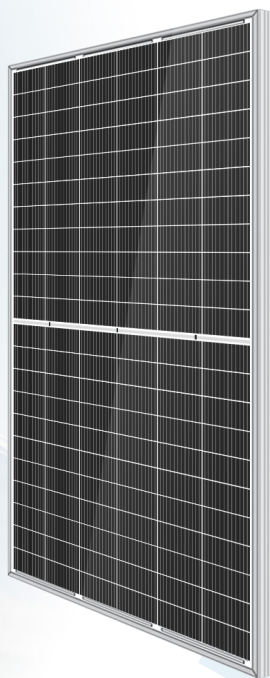

N-Type MBB Cell
New circuit design N-type cells, can increase the output power of 10W~20W



Low Light Features
Higher performance under low light environment.



Bifacial With Dual Glass
Module adopts 210*210mm half cells, bifacial module provide an additional 5%~25% output.



PID Protection
Ensure the attenuation probability caused by PID phenomenon is minimized.



Harsh Environmental Adaptability
Strict salt spray and ammonia corrosion test by TUV Nord.



Load Capacity
Mechanical load tests including wind load 2400 Pa and snow load 5400 Pa done by TUV Nord.

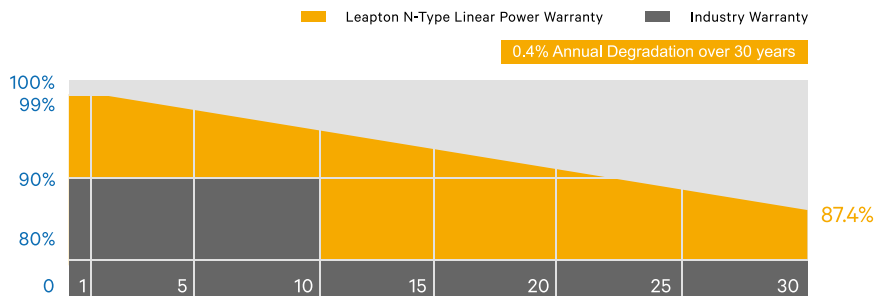

Headquarter(Kobe-shi) : Leapton Energy Co., Ltd.

Tosei Bldg. 6F, 1-2-1 Aioi-cho, Chuo-ku Kobe-shi, Hyogo, 650-0025, Japan ☎ +81-78-382-3182 ✉ info-lp@leaptonenergy.jp 🌐 www.leaptonenergy.jp

Branch Office(Tokyo)

Shinsan Bldg. 6F, 3-5-10 Shimbashi, Minato-Ku, Tokyo 105-0004, Japan ☎ +81-3-5510-7818

Manufacturer : Leapton Solar (Changshu) Co., Ltd. 📍 No.9, Sunshine Avenue, Changshu City, Jiangsu, China

MECHANICAL DIAGRAMS

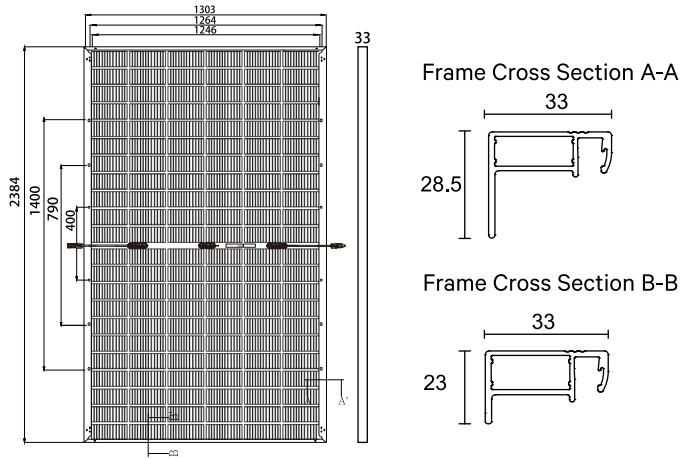

SPECIFICATIONS

Weight	37.5kg
Dimensions	2384mm*1303mm*33mm
Cell Dimensions	210*210mm
Cell Amount	66*2 pcs
Maximum System Voltage	1500V
Junction Box	IP68
Front glass	2.0mm, Anti-Reflection Coating
Back glass	2.0mm, Heat Strengthened Glass
Frame	Aluminum Alloy
Cable	4mm ² , N 1400mm/P 1400mm for Horizontal installation 4mm ² , N 320mm/P 320mm for Vertical installation
Connector	MC4 compatible
Bifaciality	80±5%

ELECTRICAL PARAMETERS AT STC

Power	700W	705W	710W	715W	720W	725W	730W	735W	740W
Open Circuit Voltage	48.20V	48.40V	48.60V	48.80V	49.00V	49.20V	49.40V	49.60V	49.80V
Short Circuit Current	18.48A	18.52A	18.57A	18.61A	18.65A	18.70A	18.74A	18.79A	18.83A
Maximum Power Voltage	40.20V	40.40V	40.60V	40.80V	41.00V	41.20V	41.41V	41.60V	41.81V
Maximum Power Current	17.41A	17.45A	17.49A	17.52A	17.56A	17.60A	17.63A	17.67A	17.70A
Module Efficiency	22.53%	22.70%	22.86%	23.02%	23.18%	23.34%	23.50%	23.66%	23.82%

* Under Standard Test Conditions (STC) of irradiance of 1000 W/m², spectrum AM 1.5 and cell temperature of 25°C.

ELECTRICAL PARAMETERS AT NMOT

Power	534W	538W	541W	545W	549W	553W	557W	560W	564W
Open Circuit Voltage	45.75V	45.95V	46.15V	46.35V	46.55V	46.75V	46.95V	47.15V	47.35V
Short Circuit Current	14.82A	14.86A	14.91A	14.94A	14.97A	15.01A	15.05A	15.09A	15.12A
Maximum Power Voltage	38.00V	38.20V	38.35V	38.55V	38.75V	38.95V	39.15V	39.35V	39.55V
Maximum Power Current	14.05A	14.08A	14.11A	14.14A	14.17A	14.20A	14.23A	14.23A	14.26A

* Under Nominal Module Operating Temperature (NMOT), irradiance of 800 W/m², spectrum AM 1.5, ambient temperature 20°C, wind speed 1 m/s.

ELECTRICAL PARAMETERS (AT 10% BIFACIAL POWER OUTPUT)

Output Power	770W	776W	781W	787W	792W	798W	803W	809W	814W
Open Circuit Voltage	48.20V	48.40V	48.60V	48.80V	49.00V	49.20V	49.40V	49.60V	49.80V
Short Circuit Current	20.27A	20.33A	20.37A	20.43A	20.47A	20.53A	20.57A	20.63A	20.66A
Maximum Power Voltage	40.20V	40.40V	40.60V	40.80V	41.00V	41.20V	41.41V	41.60V	41.81V
Maximum Power Current	19.15A	19.21A	19.24A	19.29A	19.32A	19.37A	19.39A	19.45A	19.47A

TEMPERATURE CHARACTERISTICS

NMOT	41±3°C	Temp Coefficient of ISC	+0.046%/°C
Temp Coefficient of VOC	-0.25%/°C	Temp Coefficient of Pmax	-0.30%/°C

PACKING CONFIGURATION

Modules/Pallet	34 Pieces	Modules/40'Container	612 Pieces
Packing Description	18 Pallets, Total=34x18=612 Pieces		

CHARACTERISTICS

LP210*210-M-66-NB-710W

LP210*210-M-66-NB-710W

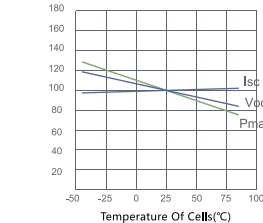
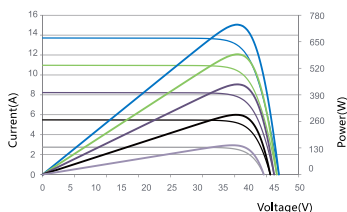

MAXIMUM RATING

Output Tolerance	0~+5W
Operating Temperature	-40°C~+85°C
Wind Load/Snow Load	2400pa/5400pa
Fuse Current	30A



LEAP SERIES

日本発の太陽光パネルメーカー
LEAP FROM JAPAN TO THE WORLD



LP182*210-M-66Q-NB

POWER RANGE 650-670W

- 1/ **L-TOPCon: The Next Evolution of TOPCon**
Enhanced through Advanced Process Innovation for 30~40W Power Gain.
- 2/ **Enhanced Rear-Side Generation**
Enhanced structure maximizes light use, boosting TOPCon bifacial efficiency.
- 3/ **Low Light Features**
Higher performance under low light environment.
- 4/ **Lower LCOE, Greater Value**
Produce More Energy and Increase Your Project Profitability.

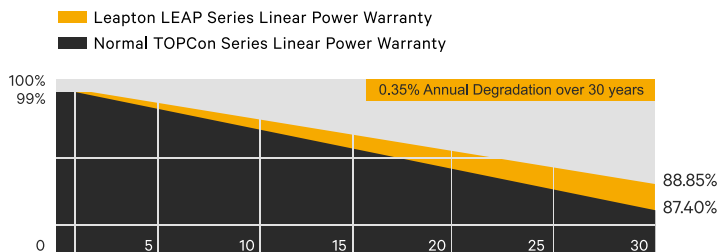
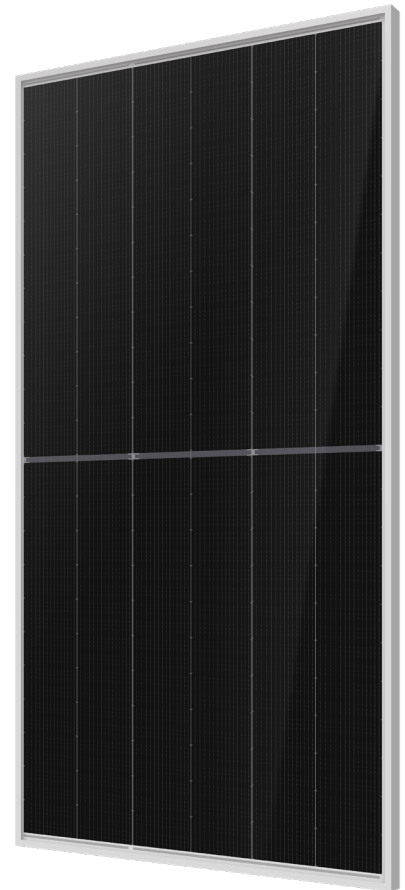

COMPREHENSIVE CERTIFICATES



DATASHEET VERSION: 2026 V1

Headquarter(Kobe-shi) : Leapton Energy Co., Ltd.

📍 Tosei Bldg. 6F, 1-2-1 Aioi-cho, Chuo-ku Kobe-shi, Hyogo, 650-0025, Japan

☎ +81-78-382-3182

✉ info-lp@leaptonenergy.jp

🌐 www.leaptonenergy.jp

Branch Office(Tokyo)

📍 Shinsan Bldg. 6F, 3-5-10 Shimbashi, Minato-Ku, Tokyo 105-0004, Japan

☎ +81-3-5510-7818

Manufacturer : Leapton Solar (Changshu) Co., Ltd.

📍 No.9, Sunshine Avenue, Changshu City, Jiangsu, China

MECHANICAL DIAGRAMS

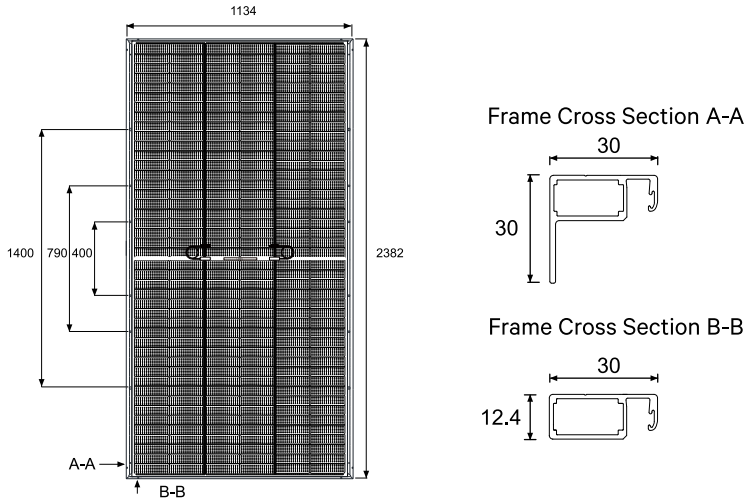

SPECIFICATIONS

Weight	32.2kg
Dimensions	2382mm*1134mm*30mm
Cell Dimensions	182*210mm
Cell Amount	66*4 pcs
Maximum System Voltage	1500V
Junction Box	IP68
Front glass	2.0mm, Anti-Reflection Coating
Back glass	2.0mm, Heat Strengthened Glass
Frame	Aluminum Alloy
Cable	4mm ² , N 1400mm/P 1400mm for Horizontal installation 4mm ² , N 500mm/P 500mm for Vertical installation
Connector	MC4 compatible
Bifaciality	85±5%

ELECTRICAL PARAMETERS AT STC

Power	650W	655W	660W	665W	670W
Open Circuit Voltage	50.28V	50.46V	50.64V	50.82V	51.00V
Short Circuit Current	15.98A	16.04A	16.10A	16.15A	16.21A
Maximum Power Voltage	42.60V	42.73V	42.86V	42.99V	43.12V
Maximum Power Current	15.26A	15.33A	15.40A	15.47A	15.54A
Module Efficiency	24.06%	24.25%	24.43%	24.62%	24.80%

* STC: Irradiance 1000W/m², Cell Temperature 25°C, AM=1.5

ELECTRICAL PARAMETERS AT NMOT

Power	494W	498W	502W	506W	510W
Open Circuit Voltage	47.77V	47.94V	48.11V	48.28V	48.45V
Short Circuit Current	13.05A	13.11A	13.17A	13.21A	13.27A
Maximum Power Voltage	40.04V	40.16V	40.29V	40.42V	40.54V
Maximum Power Current	12.34A	12.40A	12.46A	12.52A	12.58A

* NMOT: Irradiance 800W/m², Cell Temperature 20°C, AM=1.5

ELECTRICAL PARAMETERS AT BNPI

Output Power	724W	729W	735W	740W	746W
Open Circuit Voltage	50.38V	50.56V	50.74V	50.92V	51.10V
Short Circuit Current	17.81A	17.88A	17.94A	18.01A	18.08A
Maximum Power Voltage	42.69V	42.83V	42.96V	43.10V	43.22V
Maximum Power Current	16.96A	17.02A	17.11A	17.17A	17.26A

* BNPI: Front Irradiance 1000W/m², Rear Irradiance 135W/m², Cell Temperature 25°C, AM=1.5

TEMPERATURE CHARACTERISTICS

NMOT	41±3°C	Modules/Pallet	37 Pieces
Temp Coefficient of ISC	+0.046%/°C	Packing Description	20 Pallets, Total=(37+37)x10=740 Pieces
Temp Coefficient of VOC	-0.24%/°C	Modules/40'Container	740 Pieces
Temp Coefficient of Pmax	-0.26%/°C		

PACKING CONFIGURATION

CHARACTERISTICS

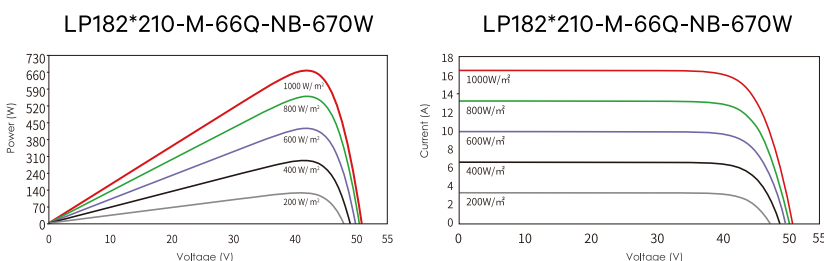

MAXIMUM RATING

Output Tolerance	0~+5W
Operating Temperature	-40°C~+70°C
Wind Load/Snow Load	2400pa/5400pa
Fuse Current	30A

25 YEARS PRODUCT WARRANTY

30 YEARS POWER WARRANTY



LEAPTON
SOLAR

LEAP FROM JAPAN TO THE WORLD

■ ■ ■ SWITCH YOUR LIFE

ENERGY SOLUTIONS

SINGLE-PHASE HYBRID INVERTER

★ IP66 PROTECTION · TOUCH LCD

Dustproof and waterproof with intuitive color touchscreen for real-time monitoring.

★ 160A HIGH CURRENT

Delivers efficient charge/discharge performance and maximizes system output.

★ 6 SMART TIME PERIODS

6 programmable charge/discharge periods for precise energy management.

★ DIESEL GENERATOR SUPPORT

Enables direct generator-to-battery charging for hybrid systems.

★ 4MS SEAMLESS SWITCHING

Only 4ms transition ensures uninterrupted and stable power supply.



Version: 2026 V3

* For the most up-to-date information, please refer to the latest version of this datasheet.

Headquarter(Kobe-shi) : Leapton Energy Co., Ltd.

📍 Tosei Bldg. 6F, 1-2-1 Aioi-cho, Chuo-ku Kobe-shi, Hyogo, 650-0025, Japan

☎ +81-78-382-3182

✉ info-lp@leaptonenergy.jp

🌐 www.leaptonenergy.jp

Branch Office(Tokyo)

📍 Shinsan Bldg. 6F, 3-5-10 Shimbashi, Minato-Ku, Tokyo 105-0004, Japan

☎ +81-3-5510-7818















Manufacturer : Leapton Solar (Changshu) Co., Ltd.

📍 No.9, Sunshine Avenue, Changshu City, Jiangsu, China













Parameters

MODEL	H6000-LS2-G5	H8000-LS2-G5
Battery Input Parameters		
Battery Type	Lithium, Lead-acid	Lithium, Lead-acid
Battery Voltage Range	40-60	40-60
Max. Charging Current (A)	120	160
Max. Discharging Current (A)	120	160
Lithium Battery Charge Management	Adaptive BMS system	Adaptive BMS system
PV Input Parameters		
Max. PV Input Power (W)	9000	12000
Max. PV Input Voltage (V)	510	510
Start-up Voltage (V)	80	80
PV Input Voltage Range (V)	125-510	125-510
MPPT Voltage Range (V)	100-425	100-425
MPPT Range at Full Load (V)	250-425	230-425
PV Nominal Input Voltage (V)	360	360
Max. Operating PV Input Current (A)	18+18	18+36
Max. PV Short-circuit Current (A)	27+27	27+54
Strings per MPPT	1+1	1+2
AC Input & Output Parameters		
Rated Output Active Power (W)	6000	8000
Max. Output Active Power (W)	6600	8800
Rated Output Current (A)	27.3/26.1	36.4/34.8
Max. Output Current (A)	27.3/26.1	36.4/34.8
Max. Fault Output Current (AC) (A)	60	80
Peak power (off-grid)	1.1 times of rated power,60s	1.1 times of rated power,60s
Grid Bypass Current (A)	50	50
Power Factor	0.8 leading to 0.8 lagging	0.8 leading to 0.8 lagging
THDi (at Full Load)	THD<3%	THD<3%
DCI	<0.5%In	<0.5%In
Switch Time(ON GRID TO OFF GRID)	4ms	4ms
Output Frequency	50/45-55, 60/55-65	50/45-55, 60/55-65
Output Voltage	220/230 0.85Un-1.1Un	220/230 0.85Un-1.1Un
Grid Type	L/N/PE	L/N/PE
Efficiency		
Max. Efficiency	97.4%	97.6%
Euro Efficiency	96.3%	96.5%
Battery-to-AC Max Efficiency	95.4%	95.5%
MPPT Efficiency	99%	99%
Protections		
DC Reverse Polarity Protection	YES	YES
Output Overcurrent Protection	YES	YES
Output Overvoltage Protection	YES	YES
Output Short Circuit Protection	YES	YES
Temmmal Protection	YES	YES
Leakage Current Monitoring	YES	YES
Insulation Resistance Detection	YES	YES
Anti-Islanding Protection	YES	YES
Overload Protection	YES	YES
Arc Fault Circuit Interrupter (AFCI)	Optional	Optional
RSD	Optional	Optional
DC Switch	YES	YES
Ground Detection	YES	YES
Surge Protection Level	TYPEII(DC/AC)	TYPEII(DC/AC)
User Interaction		
Display	LCD	LCD
Communication Interface	485+CAN	485+CAN
Monitoring Method	WIFI/Bluetooth	WIFI/Bluetooth
General Data		
Operating Temperature	-40°C to 60°C, derating >45°C	-40°C to 60°C, derating >45°C
Permissible Ambient Humidity	0-100%	0-100%
Permissible Altitude (m)	2000m	2000m
Noise (dB)	30dB	45dB
Protection Rating	IP66	IP66
Topology	Non-isolated	Non-isolated
Overvoltage Category	OVCI(DC),OVCI(AC)	OVCI(DC),OVCI(AC)
Dimensions	475±1×335±1×235±1mm	475±1×335±1×235±1mm
Weight	18kg	19kg
Container Capacity (pcs)	20GP: 288 40HQ: 832	20GP: 288 40HQ: 832
Cooling Method	Natural cooling	Smart fan
Installation method	Wall-mounted	Wall-mounted
Warranty	Standard 5 years, extended warranty	
Grid Regulation	IEC 62116,IEC 61727,IEC 61683,EN 50549	
Safety EMC/Standard	IEC/EN 61000-6-1/2/3/4,IEC/EN62109-1,IEC/EN 62109-2	

Packing List (Include)

No.	Picture	Description	Quantity
1		PV connector cable male end	3
2		PV connector cable female end	3
3		Option 1: WIFI data acquisition stick - Asia, Africa and Latin America/ Option 2: WIFI data acquisition stick - Europe	Option 1/ 2
4		CT	1
5		External NTC	1
6		Quick installation manual	1
7		Expansion screw	4
8		RJ45 connector	3
9		RNB open ground terminal	1
10		Peeping copper terminal	2
11		Barbed terminal	6
12		Ground screw	1
13		Three-way hexagon socket head screw	2
14		Accessories PE bag	5

Packing List (Optional accessories, Sold separately)

No.	Picture	Description	Quantity
1		Guide rail	1
2		Three-way hexagon socket head screw	2
3		Quick disconnect device	1
4		Terminal fastener	2
5		RSD power supply cable	1
6		Electricity meter	1
7		AFCl board	1
8		AFCl CT	2
9		3mm hole for arc support plate	1
10		Single-way hexagonal stud	2
11		Arc detection communication cable	1
12		Three-way eleven-point head screw	3
13		Three-way hexagon socket head screw	4



LEAPTON
SOLAR



SWITCH YOUR LIFE

ENERGY STORAGE SOLUTIONS

VERSION: 2026 V2

* For the most up-to-date information, please refer to the latest version of this datasheet.

LOW VOLTAGE BATTERY - EL-A16

★ HIGH ENERGY DENSITY & LONG ENDURANCE

Uses 314Ah cells for extended power supply and high-power device operation.

★ HIGH CHARGE/DISCHARGE CURRENT

Supports up to 160A for efficient performance.

★ STANDARD SC CONNECTOR

Enables flexible installation and easy replacement.

SAFE & RELIABLE

Reliable LFP battery cell with high cycle stability.

INTELLIGENT BMS

Automatically manage charge and discharge state.

HIGH EFFICIENCY

Charge and discharge with high efficiency.

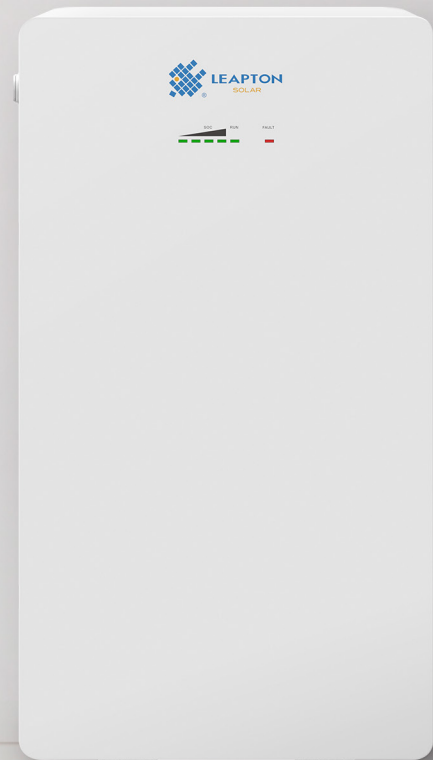

Battery Module

EL-A16

Rated Energy(kWh) ¹	16
Usable Energy (kWh) ¹	14.4
Cell Type	LFP (LiFePO4)
Cell Configuration	16S1P
Rated Capacity(Ah)	314
Nominal Voltage (V)	51.2
Operating Voltage Range (V)	40~57.6
Recommended Voltage Range (V)	44.8~56.8
Recommended Charge/ Discharge Current (A)	100
Recommended Charge/ Discharge Power (kW)	5.12
Max. Charge/ Discharge Current (A) ²	160
Max. Charge/ Discharge Power (kW) ²	8.19
Weight (kg)	120
Dimensions (W × H × D mm)	480*865*235
Communication	CAN, RS485, RS232
Operating Temperature (°C) ³	Charge: 0~55/ -20~55 (Optional), Discharge:-20~55
Operating Temperature (Recommended) (°C)	15~30
Storage Temperature (°C)	-10~55
Storage Temperature (Recommended) (°C)	20~30
Relative Humidity	5%~95%
Cycle Life	>6000 (25°C @ 77°F)
Recommended DOD	90%
Environment	Outdoor /Indoor(*Please refer to the user manual for installation condition)
Cooling Method	Natural convection
Ingress Protection Rating	IP65
Max. Number Of Parallel Connections (pcs)	15
Max. Operating Altitude (m)	2000
Mounting Method	Floor-standing
Heating Function	Optional
Certificates	IEC 62619, CE, MSDS, UN38.3
Product Warranty	10 years warranty
Compatible inverter brands	Leapton, Solis and others

1. Value for Battery Cell Only (Depth of Discharge 90%).Actual usable energy at the AC output may vary by condition, such as the battery converter, inverter efficiency and temperature.

2. Leapton Energy recommends 160A@8.19kW for maximum battery module lifetime Max dis-/charge current and power derating will occur related to temperature and SOC.

3. The battery with the heating function option is compatible with Leapton inverters (charge temperature: -20°C~55°C) and, under certain conditions, with specific third-party inverters (charge temperature: -10°C~55°C). For details, please consult Leapton by service@leaptonenergy.com

CONTACT

HEADQUARTERS (KOBE-SHI): LEAPTON ENERGY CO., LTD.

TEL: 81-78-382-3182

WEB: www.leaptonenergy.jp

ADD: F6 Tosei Building 1-2-1 Aioicho Chuo-ku, Kobe-shi, Hyogo-ken 650-0025, Japan

E-MAIL: info-lp@leaptonenergy.jp

BRANCH OFFICE (TOKYO):

TEL: 81-3-5510-7818









ADD: Shinsan Bldg. 6F, 3-5-10 Shimbashi, Minato-Ku, Tokyo 105-0004, Japan

FACTORY: LEAPTON SOLAR (CHANGSHU) CO., LTD.









ADD: No.9, Sunshine Avenue, Changshu City, Jiangsu, China

OPTIONAL ACCESSORIES (NOT INCLUDED, SOLD SEPARATELY)

EL-A16 Packing list (Include)

No.	Project	Description
1		Main Unit*1
2		User Manual*1
3		SC50-8*4
4		SC6-6*2
5		RJ45 Connector*2
6		M6 Combination Screw*4
7		M8 Combination Screw*4
8		M6*50 Expansion Screw*2
9		Fixed Plate*2

Optional accessories, Sold separately (Exclude)

No.	PN	Description	Picture
1	G.01.B.0216	Battery Power Cable(positive)*1 Size:50mm ² Length:1.2m	
		Battery Power Cable*(negative)*1 Size:50mm ² Length:1.2m	
2	G.01.B.0217	Battery Parallel Cable(positive)*1 Size:50mm ² Length:0.6m	
		Battery Parallel Cable*(negative)*1 Size:50mm ² Length:0.6m	
3	G.01.B.0018	Ground Wire*1 Size:10 AWG Length:1m	
4	G.02.B.0165	Battery Communication Cable*1 Length:1.5m	
5	G.02.B.0144	Battery Parallel Communication Cable*1 Length: 1m	
6	B.06.A.0030	Aerosol Fire Extinguishing Device*1	



LEAPTON
SOLAR

■■■ SWITCH YOUR LIFE
ENERGY STORAGE SOLUTIONS

VERSION: 2026 V1

* For the most up-to-date information, please refer to the latest version of this datasheet.



LEAPTON ENERGY

OUTDOOR BESS CABINET C240-F



DESIGNED FOR FASTER ROI IN C&I PROJECTS

Maximizes energy utilization and reduces upfront investment pressure, enabling a shorter payback period.



PROVEN, SIMPLE AND RELIABLE SYSTEM DESIGN

Built on a mature architecture to ensure stable operation, high reliability, and long service life.



LOWER O&M COST OVER SYSTEM LIFETIME

Optimized components and system design minimize maintenance needs and reduce total lifecycle costs.



EASY DEPLOYMENT, FAST COMMISSIONING

Integrated design simplifies installation and enables fast, smooth on-site commissioning.



OPTIMIZED FOR MAINSTREAM C&I APPLICATIONS

Well-suited for peak shaving, demand management, backup power, and energy cost optimization.



Headquarters(Kobe-shi): Leapton Energy Co., Ltd.

www.leaptonenergy.jp

6F Tosei Building 1-2-1 Aioicho Chuo-ku, Kobe-shi, Hyogo-ken 650-0025, Japan

info-1p@leaptonenergy.jp

Branch Office(Tokyo)

Shinsan Bldg. 6F 3-5-10 Shimbashi, Minato-Ku, Tokyo 105-0004, Japan

+ 81-3-5510-7818

Manufacturer:Leapton Solar (Changshu) Co., Ltd.

No.9 Sunshine Avenue, Changshu city, Jiangsu province, 215500, P. R. China



Integrated cabinet	C208-F	C224-F	C240-F
Cell Chemistry	LFP(LiFePO ₄)		
Module Energy (kWh)	16		
Module Nominal Voltage (V)	51.2		
Module Capacity (Ah)	314		
Cell Configuration	208S1P	224S1P	240S1P
System Nominal Voltage (V)	665.6	716.8	768
System Operating Voltage (V) ¹	582.4~759.2	627.2~817.6	672~876
System Energy (kWh)	208	224	240
System Usable Energy (kWh) ²	187.2	201.6	216
Charge/Discharge Current (Recommended) (A)	100		
Charge/Discharge Current (Max) (A)	160		
Charge/ Discharge Power (Recommended) (kW)	66.5	71.6	76.8
Charge/ Discharge Power (Max) (kW) ³	106.4	114.6	122.8
IP Rating Of Enclosure	IP55		
Dimension (W/D/H, mm)	1490*1110*2305 (no contain inverter and lifting hole positions)		
Weight Approximate(kg)	2460	2580	2700
Humidity	0~95% (non-condensing)		
Altitude(m)	≤ 2000		
Mounting Method	Outdoor		
Cooling Method	Smart fan cooling		
Communication	CAN/RS485		
Anticorrosion Grade	C4-H		
Air Conditioner Power	Cooling: 3kW Heating: 2.5kW		
Operating Temperature (°C)	Charge: 0~55, Discharge: -20~55		
Operating Temperature (Recommended) (°C)	15~30		
Storage temperature (°C)	-10~55		
Storage temperature (Recommended) (°C)	20~30		
Number Of Battery Packs Accommodated	13	14	15
Max. Parallel Units (pcs)	5		
Container Capacity (pcs)	40HQ: 9		
Noise ⁴	≤ 65dB		
Fire Protection	Aerosol fire system, Multi-sensor/Water immersion sensor,Explosion-proof ventilator,Vent valve		
Cycle Life	25 ± 2°C , 0.5C / 0.5C , EOL70% ≥ 6000		
Warranty	5 years		
Certificates	IEC62619/ CE/ UN38.3/ MSDS		
Compatible inverter brands	Leapton, Solis and others		

1. Please refer to the voltage range for battery module adaptation in the inverter technical specifications.
2. Value for Battery Cell Only (Depth of Discharge 90%). Actual usable energy at the AC output may vary by condition, such as the battery converter, inverter efficiency and temperature.
3. Max dis-/charge current and power derating will occur related to temperature and SOC.
4. Measured at a distance of 1.5 m and a height of 1 m above ground.

CH-F0P

Power Control Box

Operating Voltage	250~1000Vdc
Recommended Charge/Discharge Current	100A
Max.Charge/Discharge Current	160A
Operating Temperature Range	-20~55°C
Ingress Protection Rating	IP20
Dimensions (W/D/H)	470*740*229mm
Weight Approximate	24kg



CH-F16

16 kWh Battery Module

Battery Type	LFP(LiFePO ₄)
Nominal Voltage	51.2Vdc
Rated Capacity	314Ah
Rated Energy	16kWh
Max. Charge/Discharge Current	160A
Charge Temperature	0~55°C
Discharge Temperature	-20°C~55°C
Ingress Protection Rating	IP20
Dimensions (W/D/H)	475*778*229mm
Weight Approximate	120kg











Preview





C240-F Packing list(Include)

NO.	Project	Description
1		Parallel Connection terminal resistor*1
2		OT6-6*3
3		SC50-8*4
4		Eye bolts*4
5		Wi-Fi collector*1
6		Expansion bolt M10 x 100*4
7		CableTie*10
8		M8X16 Combination screws *4
9		User manual*1

Optional accessories,Sold separately(Exclude)

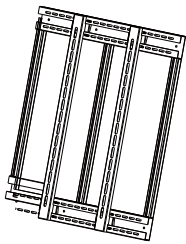
NO.	Project	Description
1		4G collector*1 (No 4G SIM card included)
2		Inverter fixed bracket *1